

8618N

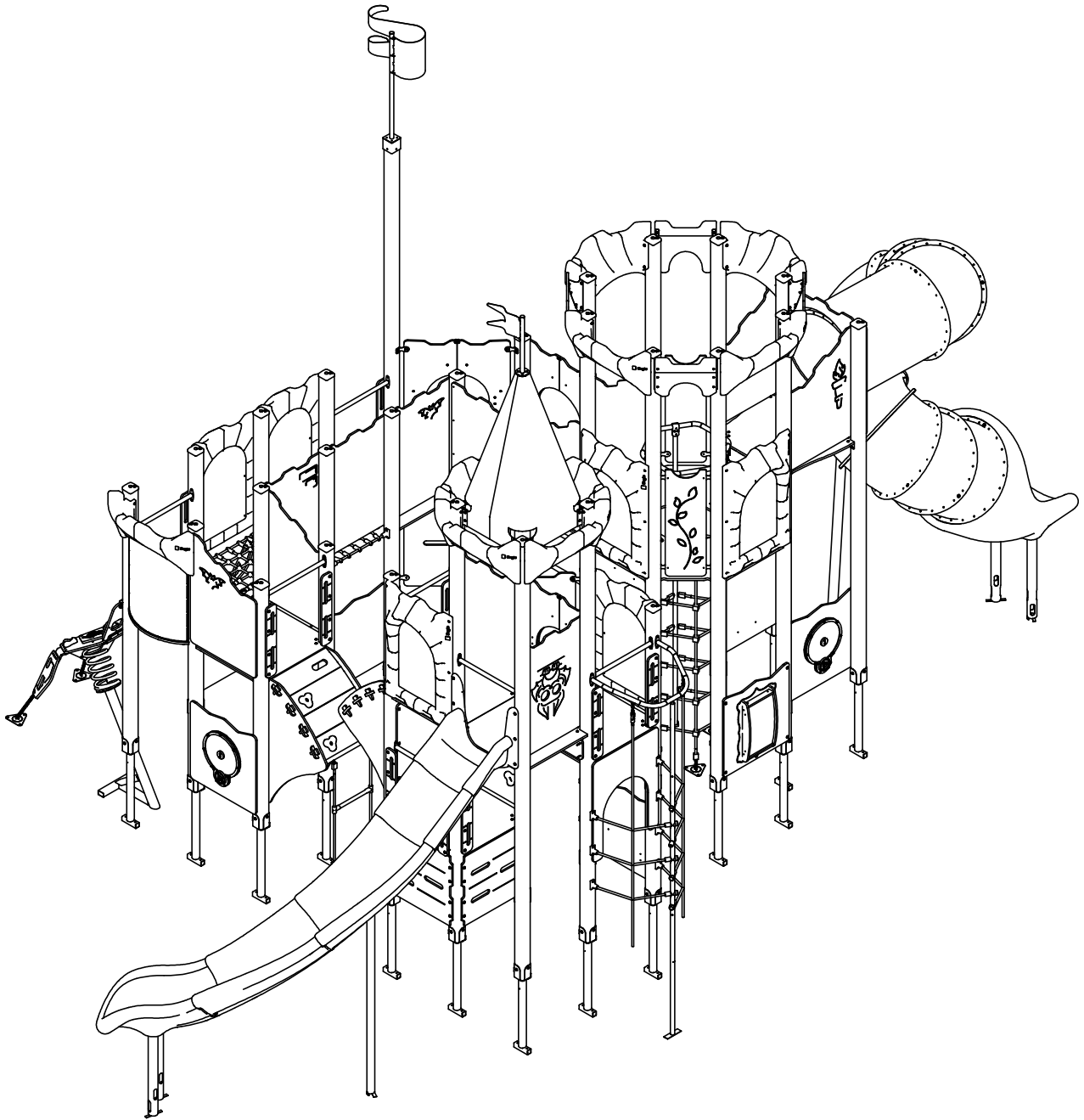

8618N

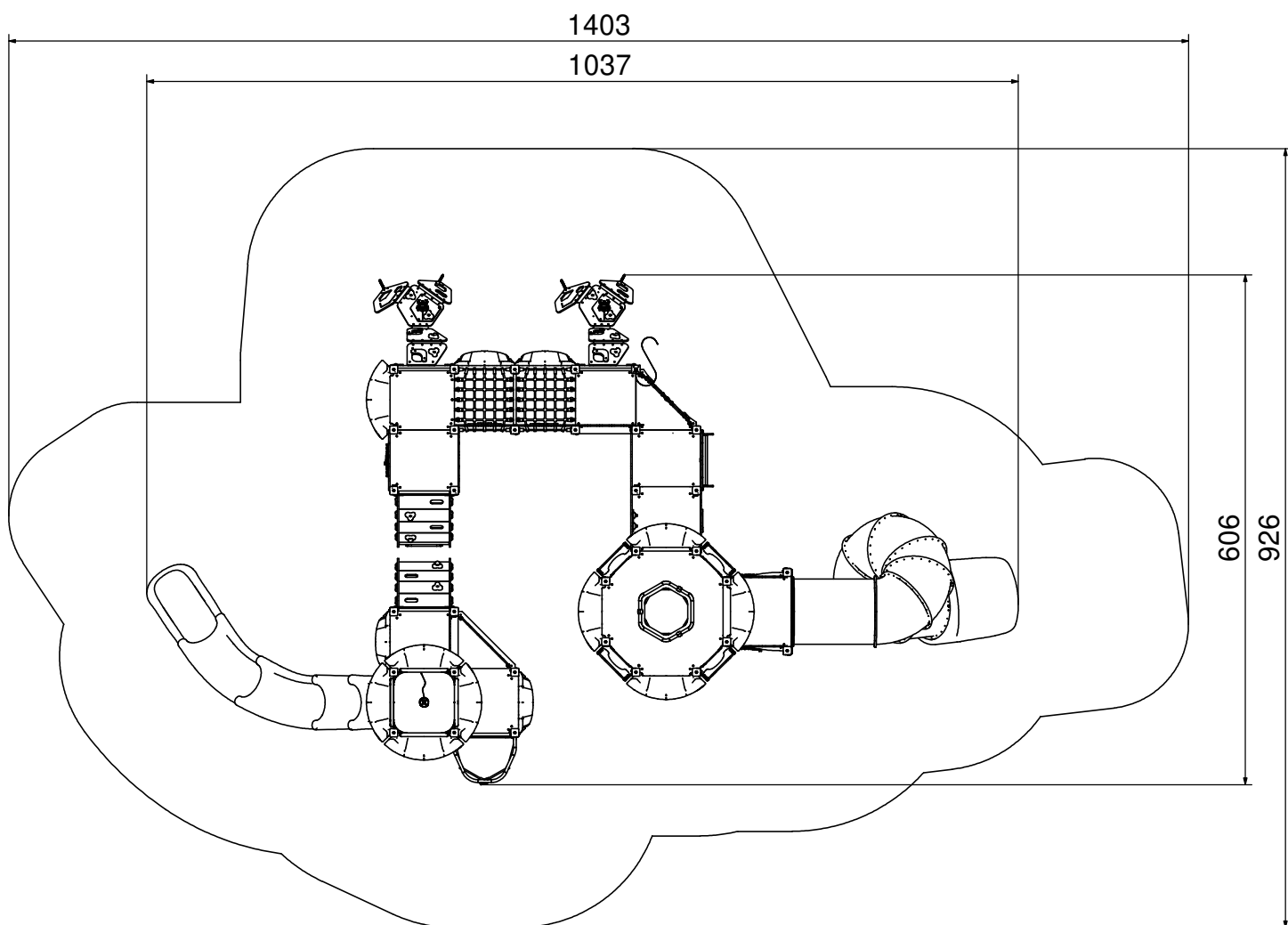
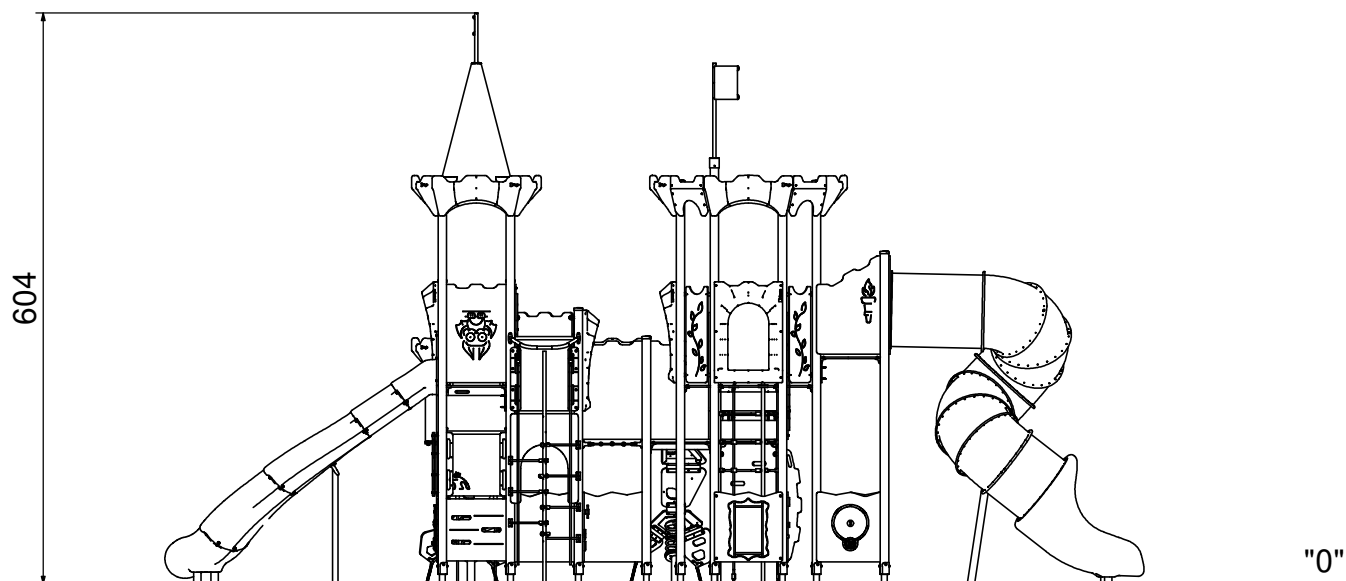

8618N

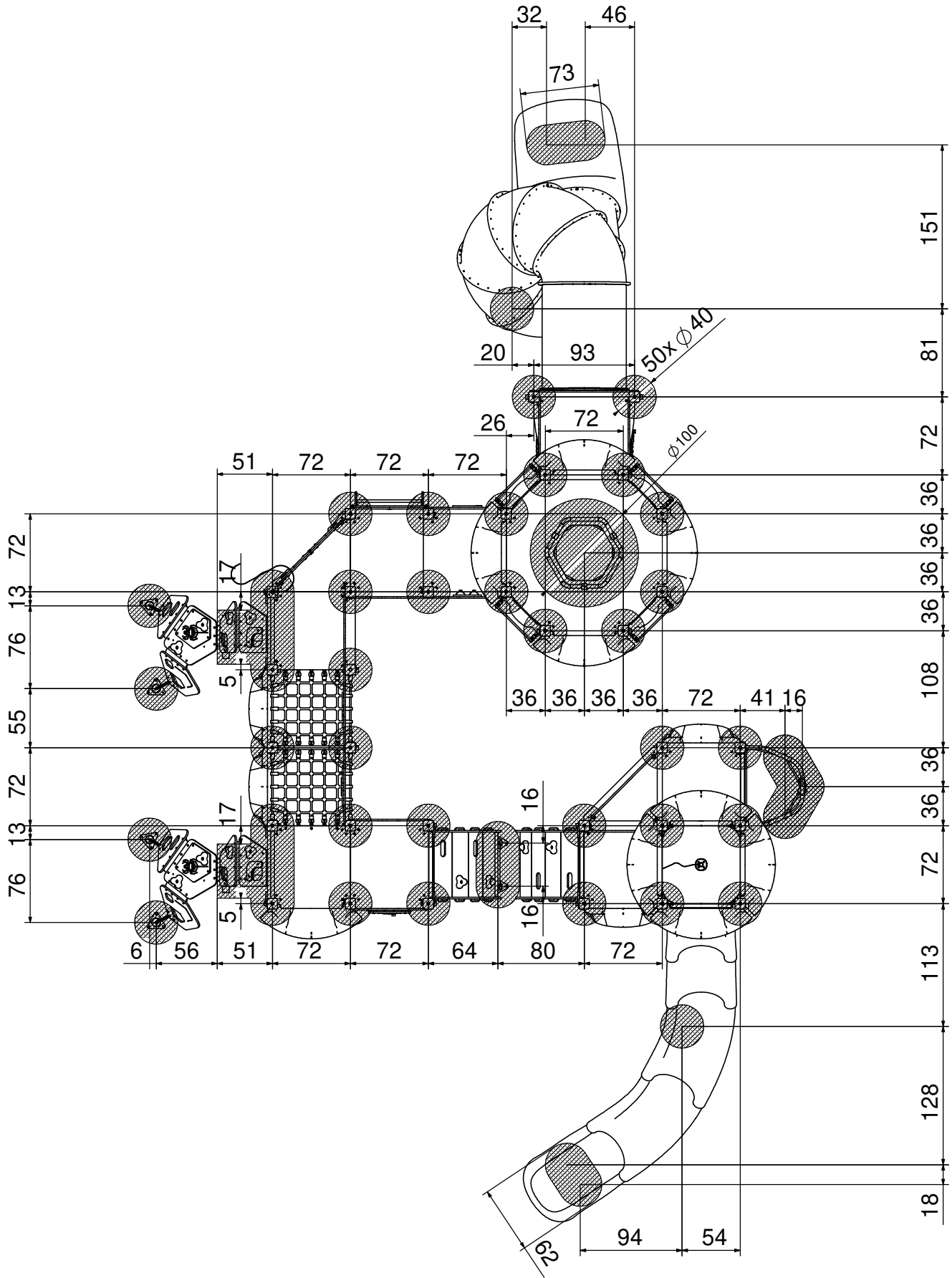

8618N

B25 1,5m³

min. 48H

